

Revision Notes.

APA: _____ Drawn: _____ Checked: _____ Approved: _____ Date: _____

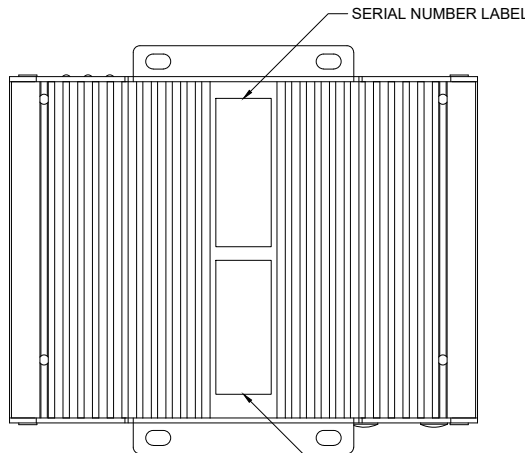
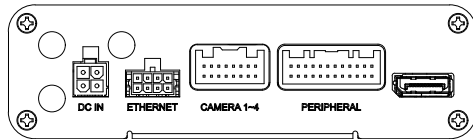
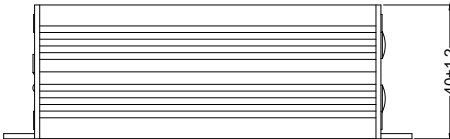
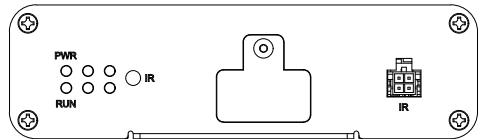
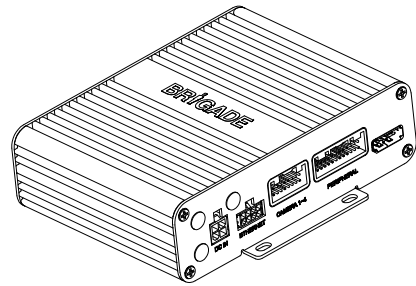
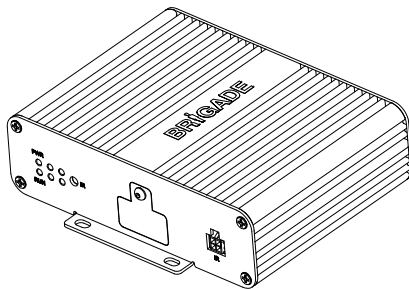
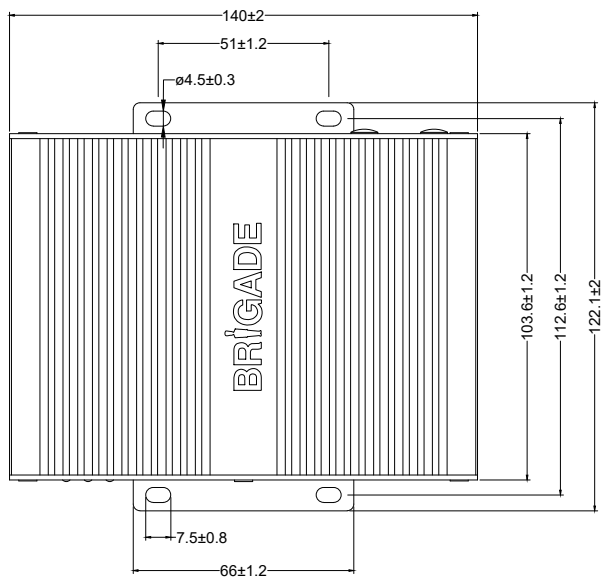

- NOTES:**
- HOUSING COLOUR IS BLACK
 - HOUSING MATERIAL IS ALUMINUM
 - FOR LABEL AND PACKAGING DETAILS REFER TO MASTER BOM.
 - FIRMWARE: 29.v3.1.01-0.0-XXXX:XXXXXXXX
 - FOR PIN OUT INFORMATION OF SOCKETS PLEASE SEE ASSOCIATED CABLE DRAWINGS
 - PRODUCT AND SERIAL NUMBER LABEL PLACED ON REAR OF ECU, PLACEMENT IS CONTROLLED BY SUPPLIER.
 - ANY CUSTOMER MODIFICATION OF THIS PRODUCT CAUSING SUBSEQUENT FAILURE IS NOT A LIABILITY OF BRIGADE ELECTRONICS GROUP PLC.

PROPRIETARY NOTICE
 THIS DESIGN AND TECHNICAL INFORMATION APPEARING ON THIS DRAWING IS THE PROPERTY OF BRIGADE ELECTRONICS, AND IS DISCLOSED IN CONFIDENCE. IT IS NOT TO BE COPIED, REPRODUCED, REVEALED TO OR EXPROPRIATED BY OTHERS, EITHER IN WHOLE OR IN PART WITHOUT THE EXPRESS WRITTEN CONSENT OF BRIGADE ELECTRONICS.



Assembly Pl Approval W.XIA	Approved by JN BATOUR	Checked by A. FOSTER	Drawn by A.KING
Angle of Projection 	Units mm	Scale N/A	Released 12/09/24
	Status RELEASED	VBV-360-1000-ECU-AI	
	Part No 7525	BE-004852-00-23	